

描述/Description

- XNS24S72F6基于Trench FS-IGBT技术，是一款先进的DIP25 IPM，为交流感应、直流无刷电机和PMSM电机提供非常全面的高性能逆变器输出平台。
XNS24S72F6 is an Advanced DIP25 IPM Based on Trench FS-IGBT Technology, Providing a Fully-featured, High-performance Inverter Output Stage for AC Induction, BLDC, and PMSM Motors.
- XNS24S72F6综合优化了IGBT的栅极驱动以最小化电磁干扰和能量损耗，同时也提供多重保护特性，包括集成欠压闭锁、过流保护、温度检测和故障报告。
XNS24S72F6 Optimized Gate Drive of the Built-in IGBTs to Minimize EMI and Losses, while also Providing Multiple Protection Features Including Under-voltage Lockouts, Over-current Shutdown, Thermal Monitoring, Fault Reporting.
- XNS24S72F6内置高速HVIC，提供无光耦单电源IGBT栅极驱动能力，进一步减小了逆变器系统设计的总体尺寸。
XNS24S72F6 Combines High Speed HVIC Provides Opto-Coupler-Less Single-Supply IGBT Gate Driving Capability that Further Reduce the Overall Size of the Inverter System Design.
- 独立的IGBT负端在每个相位均有效，可支持大量不同种类的控制算法。
Separate Negative IGBT Terminals are Available for Each Phase to Support the Widest Variety of Control Algorithms.

主要特点

- 600V-24 A三相IGBT逆变器，包含栅极驱动和保护的控制IC
- 低损耗、短路额定的IGBT
- 内置带限流电阻的自举二极管
- 低端IGBT的独立发射极开路引脚用于三相电流感测
- 内置负温度系数的电阻用于温度检测
- 全隔离DIP25封装
- 绝缘级别2500V_{rms}/1min
- 单接地电源供电
- 无铅工艺；符合ROHS

Features

- 600V-24A 3-Phase IGBT Inverter Bridge Including Control ICs for Gate Driving and Protection
- Low-Loss, Short-Circuit Rated IGBTs
- Built-In Bootstrap Diodes with Current Limiting Resistor
- Separate Open-Emitter Pins from Low-Side IGBTs for Three-Phase Current Sensing
- Built-In NTC Thermistor for Temperature Monitoring
- Fully Isolated DIP25 Package
- Isolation Rating: 2500 V_{rms}/min
- Single-Grounded Power Supply
- Lead-free Terminal Plating; RoHS Compliant

应用

- 运动控制 – 家用设备 / 工业电机

Applications

- Motion Control – Home Appliance / Industrial Motor



图1. 封装概览

Figure1. Package Overview

引脚号/Pin Number	引脚名/Pin Name	引脚描述/Pin Description
1	NC	No connection 空引脚
2	VUFB	High-Side Bias Voltage for U-Phase IGBT Driving 上桥臂U相驱动正端
3	VVFB	High-Side Bias Voltage for V-Phase IGBT Driving 上桥臂V相驱动正端
4	VWFB	High-Side Bias Voltage for W-Phase IGBT Driving 上桥臂W相驱动正端
5	UP	Signal Input for High-Side U Phase 上半桥U相逻辑输入端
6	VP	Signal Input for High-Side V Phase 上半桥V相逻辑输入端
7	WP	Signal Input for High-Side W Phase 上半桥W相逻辑输入端
8	VP1	Common Bias Voltage for IC and IGBTs Driver 控制电源正端
9	VNC	Common Supply Ground 下桥臂参考地端
10	UN	Signal Input for Low-Side U Phase 下桥臂U相逻辑输入端
11	VN	Signal Input for Low-Side V Phase 下桥臂V相逻辑输入端
12	WN	Signal Input for Low-Side W Phase 下桥臂W相逻辑输入端
13	VN1	Common Bias Voltage for IC and IGBTs Driver 控制电源正端
14	FO	Fault Output 故障信号输出端
15	CIN	Capacitor for Short-Circuit Current Detector Input 过流电流保护电压检测端
16	VNC	Common Supply Ground 下桥臂参考地端
17	VTH	热敏电阻电压 NTC Voltage
18	NW	Negative DC-Link Input for W-Phase 逆变器直流电源负端 (W相)
19	NV	Negative DC-Link Input for V-Phase 逆变器直流电源负端 (V相)
20	NU	Negative DC-Link Input for U-Phase 逆变器直流电源负端 (U相)
21	W	Output for W-Phase 逆变器W相输出端
22	V	Output for V-Phase 逆变器V相输出端
23	U	Output for U-Phase 逆变器U相输出端
24	P	Positive DC-Link Input 逆变器直流电压正端
25	NC	N.C 空引脚

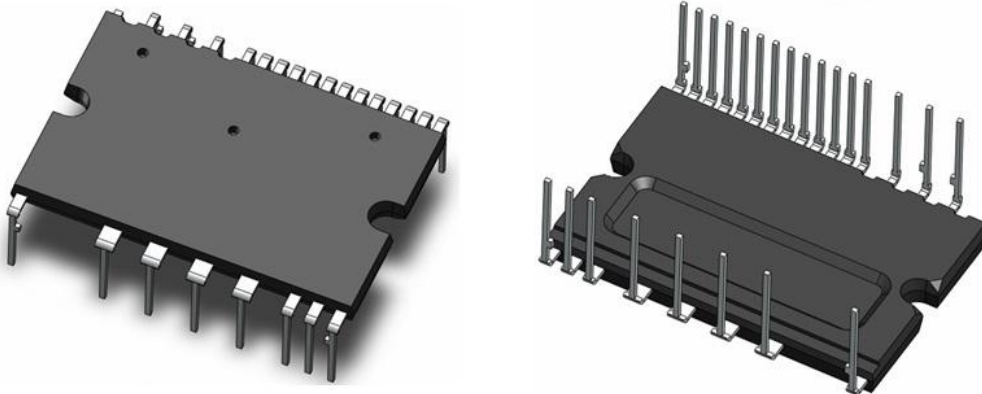
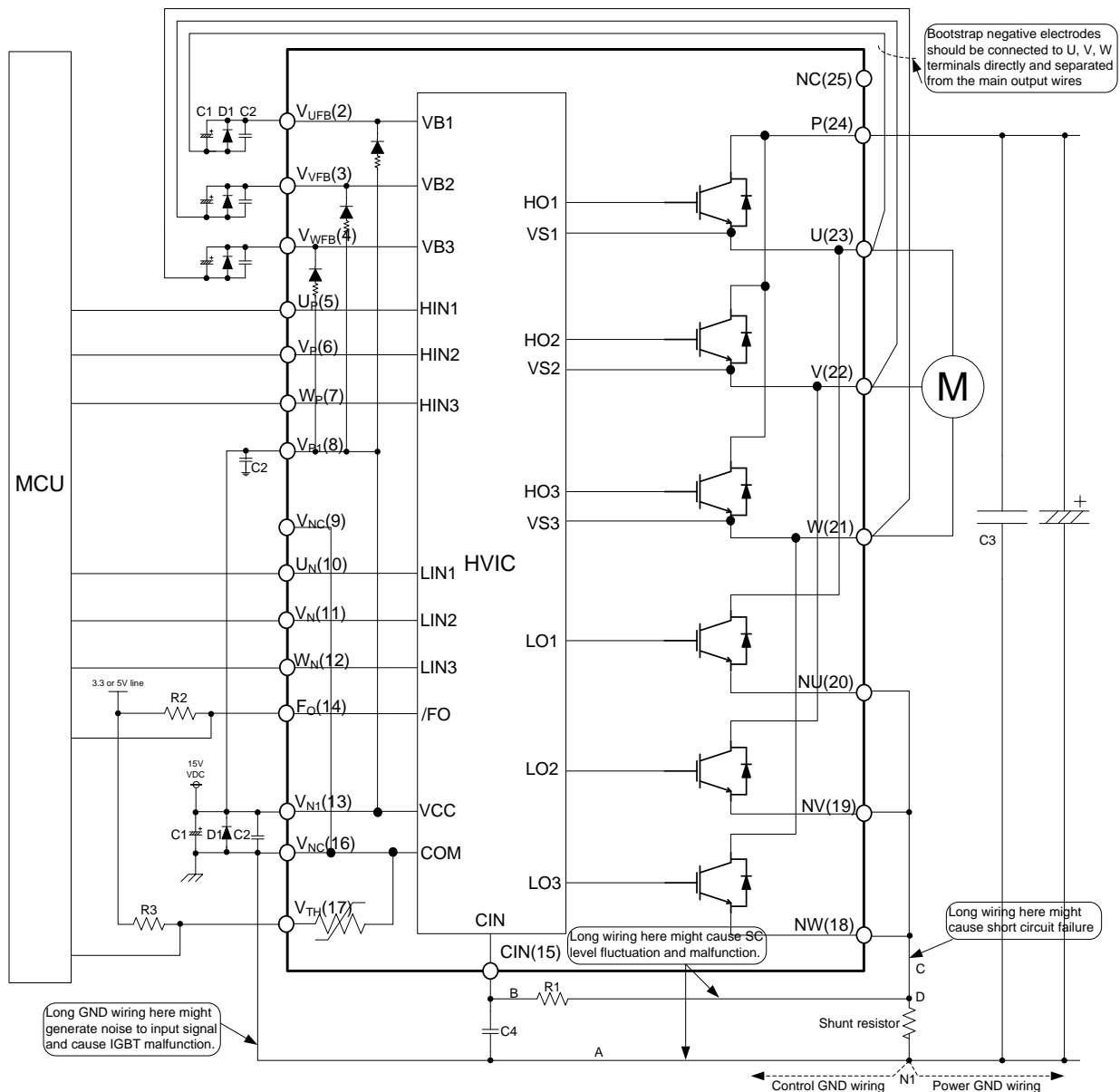

Typical Application Circuit

注/Note:

1. 推荐在电源上加稳压二极管D1 (24V/1W)，防止浪涌电压损坏IPM。
It is recommended to insert a Zener diode D1 (24V/1W) between each pair of control supply terminals to prevent surge destruction.
2. 输入正逻辑，下拉电阻5.4KΩ。为了避免故障，应尽可能缩短每个输入端的连线（小于2-3 cm）。
Input logic is High-active. There is a 5.4KΩ pull down resistor. To avoid malfunction, the wiring of each input should be as short as possible (less than 2-3cm).
3. 为避免保护功能出错，应尽可能缩短R1和C4 周围的连线。
To prevent errors of the protection function, the wiring of B, C and D point should be as short as possible.
4. 在短路保护电路中，R1C4 的时间常数应在1.5 ~ 2.0 μs 的范围内进行选择。
In the short-circuit protection circuit, please select the R1C4 time constant in the range 1.5 ~ 2.0 μs.
5. 每个电容都应尽可能地靠近产品的引脚安装。（C1: 温度特性好，频率特性好；C2: 0.22u-2uF, 温度特性好，频率特性好）
Each capacitor should be mounted as close to the pins of the product as possible. (C1: good temperature, frequency characteristic electrolytic type and C2: 0.22u-2uF, good temperature, frequency and DC bias characteristic ceramic type are recommended.)
6. 为防止浪涌的破坏，应尽可能缩短滤波电容和P & GND 引脚间的连线。推荐在P & GND 引脚间使用0.1 ~ 0.22 μF 的高频无感电容C3。
To prevent surge destruction, the wiring between the smoothing capacitor and the P & GND pins should be as short as possible. The use of a high-frequency non-inductive C3 capacitor of around 0.1 ~ 0.22 μF between the P & GND pins is recommended.

轮廓封装详图 / Detailed Package Outline Drawings

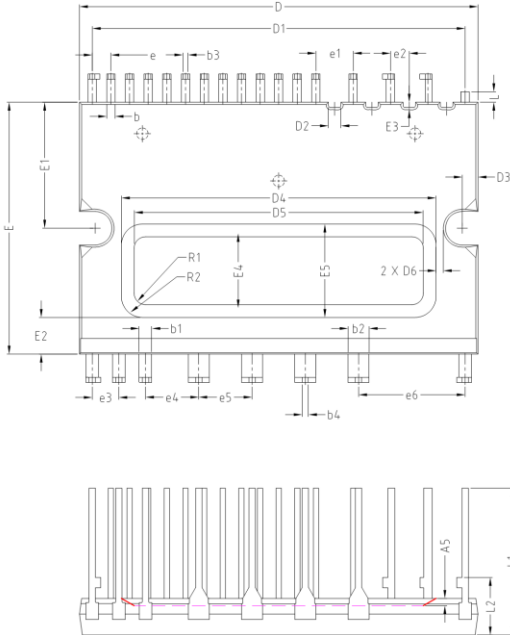

S Y M B O L	COMMON			S Y M B O L	COMMON		
	Dimensions millimeter				Dimensions millimeter		
	Min	Nom	Max		Min	Nom	Max
A	3.35	3.50	3.65	E2	3.35	3.50	3.65
A1	0.85	1.00	1.15	E3	0.35	0.50	0.65
A2	1.35	1.50	1.65	E4	6.33	6.48	6.63
A3	0.55	0.70	0.85	E5	8.75	8.90	9.05
A4	0.35	0.50	0.65	E6	29.00	29.40	29.80
A5	0.55	0.70	0.85	E7	0.85	1.00	1.15
b	0.74	0.83	0.92	E8	1.35	1.50	1.65
b1	1.14	1.23	1.32	e	1.728	1.778	1.828
b2	1.94	2.03	2.12	e1	3.506	3.556	3.606
b3	0.44	0.53	0.62	e2	1.728	1.778	1.828
b4	0.54	0.63	0.72	e3	2.490	2.540	2.590
C	0.426	0.516	0.606	e4	5.030	5.080	5.130
D	37.85	38.00	38.15	e5	5.030	5.080	5.130
D1	35.41	35.56	35.71	e6	10.11	10.16	10.21
D2	1.05	1.20	1.35	L	0.91	1.00	1.09
D3	1.35	1.50	1.65	L1	13.80	14.00	14.20
D4	29.85	30.00	30.15	L2	5.40	5.50	5.60
D5	27.43	27.58	27.73	Q	90°	90°	95°
D6	0.64	0.69	0.74	Q1	7°	8°	9°
E	23.85	24.00	24.15	Q2	7°	8°	9°
E1	11.85	12.00	12.15				