

XNG75PI24TC4AS5

IGBT Modules

General Description

Xiner IGBT Power Module XNG75PI24TC4AS5 provides low switching loss as well as high short circuit capability, which introduce the advanced IGBT and improved connection, it is able to take on a perfect performance in various applications up to 20KHz.

Features

- Standard housing
- High short circuit capability
- V_{cesat} with positive temperature coefficient

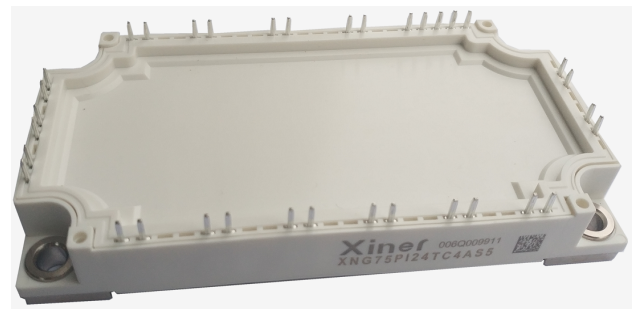

Applications

- Motor drives
- UPS
- Electronic welding
- High power converters

Characteristic values

Absolute Maximum Ratings

Parameter	Symbol	Conditions	Value	Unit
Collector-emitter voltage	V_{CES}	$T_{vj} = 25^{\circ}C$	1200	V
Gate-emitter peak voltage	V_{GES}		± 20	V
Continuous DC collector current	$I_{C\ nom}$		75	A
Repetitive peak collector current	I_{CRM}	$t_p = 1\ ms$	150	A
Total power dissipation	P_{tot}	$T_C = 25^{\circ}C, T_{vj} = 150^{\circ}C$	480	W
IGBT short circuit SOA	t_{psc}	$V_{CC} = 900\ V$ $V_{GE} = 15\ V, T_{vj} = 150^{\circ}C$	10	us

Diode DC forward current	I_F		75	A
Peak forward current	I_{FRM}		150	A
Isolation voltage	V_{isol}	$f=50\text{Hz}, 1\text{min},$	2500	V
Operating Junction	$T_{vj(op)}$		-40 ~ +150	°C
Storage Temperature	T_{stg}		-40 ~ +150	°C
Mounting torque		Screw M5	3.0~5.0	N•M

Characteristics

IGBT, Inverter

Parameter	Symbol	Conditions	Value			Unit
			min	typ	max	
Gate-emitter threshold voltage	$V_{GE(th)}$	$I_C=3\text{mA}, V_{CE}=V_{GE}, T_{vj}=25^\circ\text{C}$	5		7	V
Collector-emitter cut-off current	I_{CES}	$V_{CE}=1200\text{V}$ $V_{GE}=0\text{V}$	$T_{vj}=25^\circ\text{C}$		1	mA
			$T_{vj}=125^\circ\text{C}$		10	
Gate-emitter cut-off current	I_{GES}	$V_{CE}=0\text{V}, V_{GE}=\pm 20\text{V}$ $T_{vj}=125^\circ\text{C}$	-500		500	nA
Collector-emitter saturation voltage	$V_{CE sat}$	$I_C=75\text{A}$ $V_{GE}=15\text{V}$	$T_{vj}=25^\circ\text{C}$		1.9	V
			$T_{vj}=125^\circ\text{C}$		2.0	V
Gate charge	Q_G	$I_C=75\text{A}, V_{CE}=600\text{V},$ $V_{GE}=\pm 15\text{V}$		780		nC
Input capacitance	C_{ies}	$V_{CE}=25\text{V}, V_{GE}=0\text{V}$ $f=1\text{MHz}, T_{vj}=25^\circ\text{C}$		5.52		nF
Output capacitance	C_{oes}			0.40		
Reverse transfer capacitance	C_{res}			0.26		
Internal gate resistance	R_{Gint}			3		Ω
Turn-on delay time, inductive load	$t_{d on}$	$V_{CC}=600\text{V}$ $I_C=75\text{A}$ $V_{GE}=\pm 15\text{V}$ $R_G=5\Omega$ $L=200\text{nH},$ Inductive load	$T_{vj}=25^\circ\text{C}$		165	nS
			$T_{vj}=125^\circ\text{C}$		175	
Rise time, inductive load	t_r		$T_{vj}=25^\circ\text{C}$		75	
			$T_{vj}=125^\circ\text{C}$		70	
Turn-off delay time, inductive load	$t_{d off}$		$T_{vj}=25^\circ\text{C}$		435	nS
			$T_{vj}=125^\circ\text{C}$		500	
Fall time, inductive load	t_f		$T_{vj}=25^\circ\text{C}$		50	
			$T_{vj}=125^\circ\text{C}$		70	
Turn-on energy loss per pulse	E_{on}		$T_{vj}=25^\circ\text{C}$		6	mJ
			$T_{vj}=125^\circ\text{C}$		8	
Turn-off energy loss per pulse	E_{off}	$T_{vj}=25^\circ\text{C}$		4.5	mJ	
		$T_{vj}=125^\circ\text{C}$		7.5		
SC data	I_{SC}	$t_{psc} \leq 10\ \mu\text{s}, V_{GE}=15\text{V},$ $T_{vj}=125^\circ\text{C}, V_{CC}=900\text{V}$		350		A
Thermal resistance, junction to case		per IGBT			0.26	K/W
Thermal resistance, case to heatsink		per IGBT/ $\lambda_{grease}=1\text{W}/(\text{m}\cdot\text{K})$		0.13		K/W

Diode, Inverter

Parameter	Symbol	Conditions	Value			Unit
			Min	typ	max	
Forward voltage	V_F	$I_F = 75\text{ A}$	$T_{vj}=25^\circ\text{C}$	1.8		V
			$T_{vj}=125^\circ\text{C}$	1.9		
Peak reverse recovery current	I_{rr}	$V_{CC}=600\text{V}$ $I_C = 75\text{A}$	$T_{vj}=25^\circ\text{C}$	65		A
			$T_{vj}=125^\circ\text{C}$	85		
Recovered charge	Q_{rr}	$V_{GE}=\pm 15\text{V}$ $R_G = 5\Omega$	$T_{vj}=25^\circ\text{C}$	11		uC
			$T_{vj}=125^\circ\text{C}$	19		
Reverse recovery time	t_{rr}	$L=200\text{nH}$, Inductive load	$T_{vj}=25^\circ\text{C}$	250		nS
			$T_{vj}=125^\circ\text{C}$	360		
Reverse recovery energy	E_{rec}		$T_{vj}=25^\circ\text{C}$	6		mJ
			$T_{vj}=125^\circ\text{C}$	7.5		
Thermal resistance, junction to case	R_{thJC}	per diode			0.62	K/W
Thermal resistance, case to heatsink	R_{thCH}	per diode/ $\lambda_{grease}=1\text{W}/(\text{m}\cdot\text{K})$		0.21		K/W

Diode, Rectifier

Absolute Maximum Ratings

Parameter	Symbol	Conditions	Value			Unit
			Min	typ	max	
Repetitive peak reverse voltage	V_{RRM}	$T_{vj}=25^\circ\text{C}$		1600		V
Maximum RMS forward current per chip	I_{FRMSM}	$T_C=80^\circ\text{C}$		80		A
Maximum RMS current at rectifier output	I_{RMSM}	$T_C=80^\circ\text{C}$		140		A
Surge forward current	I_{FSM}	$t_p = 10\text{ ms}, T_{vj} = 25^\circ\text{C}$		600		A
		$t_p = 10\text{ ms}, T_{vj} = 150^\circ\text{C}$		470		

Characteristics

Parameter	Symbol	Conditions	Value			Unit
			Min	typ	max	
Forward voltage	V_F	$T_{vj} = 150^\circ\text{C}, I_F = 75\text{ A}$		1.2		V
Reverse current	I_R	$T_{vj} = 150^\circ\text{C}, V_R = 1600\text{ V}$		1		mA
Thermal resistance, junction to case	R_{thJC}	per diode			0.65	K/W
Thermal resistance, case to heatsink	R_{thCH}	per diode/ $\lambda_{grease}=1\text{W}/(\text{m}\cdot\text{K})$		0.21		K/W
Operating Junction	$T_{vj\text{ op}}$		-40		150	$^\circ\text{C}$

IGBT, Brake-Chopper Absolute Maximum Ratings

Parameter	Symbol	Conditions	Value			Unit
			Min	typ	max	
Collector-emitter voltage	V_{CES}	$T_{vj} = 25^{\circ}\text{C}$		1200		V
Continuous DC collector current	$I_{C\text{ nom}}$	$T_C = 95^{\circ}\text{C}, T_{vj\text{ max}} = 175^{\circ}\text{C}$		50		A
Repetitive peak collector current	I_{CRM}	$t_p = 1\text{ ms}$		100		A
Total power dissipation	P_{tot}	$T_C = 25^{\circ}\text{C}, T_{vj} = 150^{\circ}\text{C}$			380	W
Gate-emitter peak voltage	V_{GES}		-20		20	V

Characteristics

Parameter	Symbol	Conditions	Value			Unit
			Min	typ	max	
Collector-emitter saturation voltage	$V_{CE\text{ sat}}$	$I_C = 50\text{ A}$ $V_{GE} = 15\text{ V}$	$T_{vj} = 25^{\circ}\text{C}$	1.8		V
			$T_{vj} = 125^{\circ}\text{C}$	1.9		
Gate threshold voltage	V_{GEth}	$I_C = 2\text{ mA}, V_{CE} = V_{GE}, T_{vj} = 25^{\circ}\text{C}$	5		7	A
Gate charge	Q_G	$V_{GE} = \pm 15\text{ V}$		610		nC
Internal gate resistor	R_{Gint}	$T_{vj} = 25^{\circ}\text{C}$		10		Ω
Input capacitance	C_{ies}	$f = 1\text{ MHz}, T_{vj} = 25^{\circ}\text{C}$		4.29		nF
Reverse transfer capacitance	C_{res}	$V_{CE} = 25\text{ V}, V_{GE} = 0\text{ V}$		0.3		
Collector-emitter cut-off current	I_{CES}	$V_{CE} = 1200\text{ V}$ $V_{GE} = 0\text{ V}$	$T_{vj} = 25^{\circ}\text{C}$		1	mA
			$T_{vj} = 125^{\circ}\text{C}$		10	
Gate-emitter leakage current	I_{GES}	$V_{CE} = 0\text{ V}, V_{GE} = 20\text{ V}$ $T_{vj} = 25^{\circ}\text{C}$	-500		500	nA
Turn-on delay time, inductive load	$t_{d\text{ on}}$	$V_{CC} = 600\text{ V}$ $I_C = 50\text{ A}$ $V_{GE} = \pm 15\text{ V}$ $R_G = 3.9\Omega$ $L = 200\text{ nH}$, Inductive load	$T_{vj} = 25^{\circ}\text{C}$	230		nS
Rise time, inductive load	t_r		$T_{vj} = 125^{\circ}\text{C}$	250		
			$T_{vj} = 25^{\circ}\text{C}$	35		
Turn-off delay time, inductive load	$t_{d\text{ off}}$		$T_{vj} = 125^{\circ}\text{C}$	44		nS
			$T_{vj} = 25^{\circ}\text{C}$	280		
Fall time, inductive load	t_f		$T_{vj} = 125^{\circ}\text{C}$	330		
			$T_{vj} = 25^{\circ}\text{C}$	350		
Turn-on energy loss per pulse	E_{on}		$T_{vj} = 25^{\circ}\text{C}$	3.5		mJ
			$T_{vj} = 125^{\circ}\text{C}$	4.5		
Turn-off energy loss per pulse	E_{off}		$T_{vj} = 25^{\circ}\text{C}$	4.5		mJ
		$T_{vj} = 125^{\circ}\text{C}$	5.1			
SC data	I_{SC}	$t_{psc} \leq 10\text{ }\mu\text{s}, V_{GE} = 15\text{ V}, T_{vj} = 125^{\circ}\text{C}, V_{CC} = 900\text{ V}$		200		A
Thermal resistance, junction to case	R_{thJC}	per IGBT			0.33	K/W
Thermal resistance, case to heatsink	R_{thCH}	per IGBT/ $\lambda_{grease} = 1\text{ W}/(\text{m}\cdot\text{K})$		0.245		K/W
Operating Junction	$T_{vj\text{ op}}$		-40		150	$^{\circ}\text{C}$

Diode, Brake-Chopper Absolute Maximum Ratings

Parameter	Symbol	Conditions	Value			Unit
			Min	typ	max	
Repetitive peak reverse voltage	V _{RRM}	T _{vj} = 25°C		1200		V
Continuous DC forward current	I _F			25		A
Repetitive peak forward current	I _{FRM}	t _p = 1 ms		50		A

Characteristics

Parameter	Symbol	Conditions	Value			Unit
			Min	typ	max	
Forward voltage	V _F	I _F = 25 A V _{GE} = 0 V	T _{vj} =25°C	1.8		V
			T _{vj} =125°C	1.9		
Peak reverse recovery current	I _{rr}	I _F = 25 A di/dt=1000A/	T _{vj} =25°C	40		A
			T _{vj} =125°C	55		
Recovered charge	Q _{rr}	μ s (T _{vj} =150°C)	T _{vj} =25°C	7.5		uC
			T _{vj} =125°C	9		
Reverse recovery time	t _{rr}	V _R = 600 V	T _{vj} =25°C	220		nS
			T _{vj} =125°C	255		
Reverse recovery energy	E _{rec}		T _{vj} =25°C	4.5		mJ
			T _{vj} =125°C	5.8		
Thermal resistance, junction to case	R _{thJC}	per diode			0.7	K/W
Thermal resistance, case to heatsink	R _{thCH}	per diode/ λ _{grease} =1W/(m·K)		0.61		K/W
Operating Junction	T _{vj op}		-40		150	°C

NTC-thermistor Characteristics

Parameter	Symbol	Conditions	Value			Unit
			Min	typ	max	
Rated resistance	R ₂₅	T _C = 25°C		5		KΩ
Deviation of R	Δ R/R	T _C = 25°C	-3		3	%
Power dissipation	P ₂₅	T _C = 25°C		20		mW
B-value	B _{25/50}	R ₂ = R ₂₅ exp [B _{25/50} (1/T ₂ - 1/(298,15 K))]		3375		K

Module

Parameter	Symbol	Conditions	Value			Unit
			Min	typ	max	
Thermal resistance, case to heatsink	R_{thCH}	permodule $\lambda_{grease}=1W/(m\cdot K)$		0.007		K/W
Stray inductance module	L_{sCE}			40		nH
Module lead resistance terminal-chip	$R_{CC'+EE'}$	$T_{vj}=25^{\circ}C$		0.7		m Ω
		$T_{vj}=125^{\circ}C$		0.8		
Weight	G			300		g

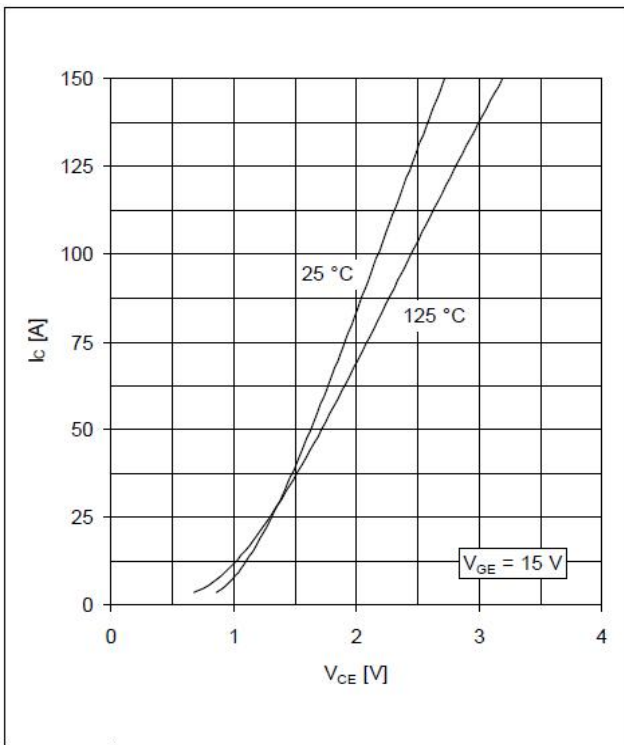

Figure 1: Typical Output Characteristics

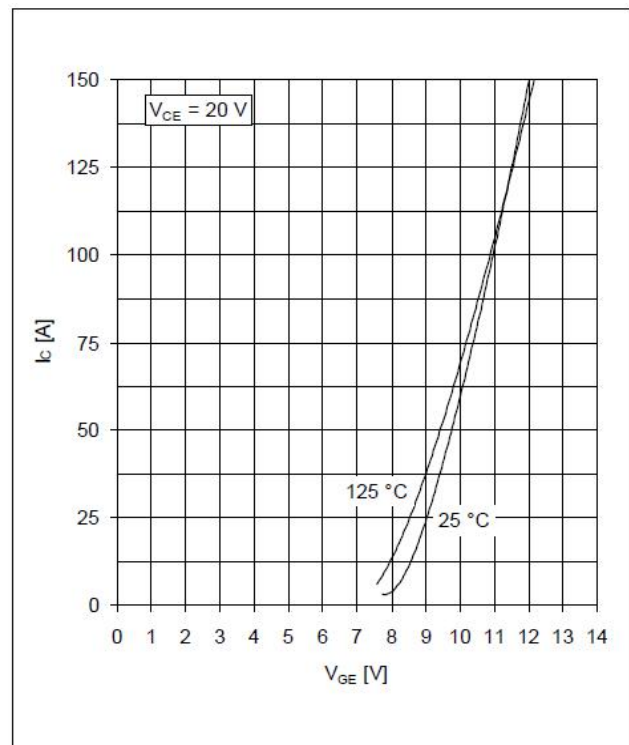

Figure 2: Typical Output Characteristics

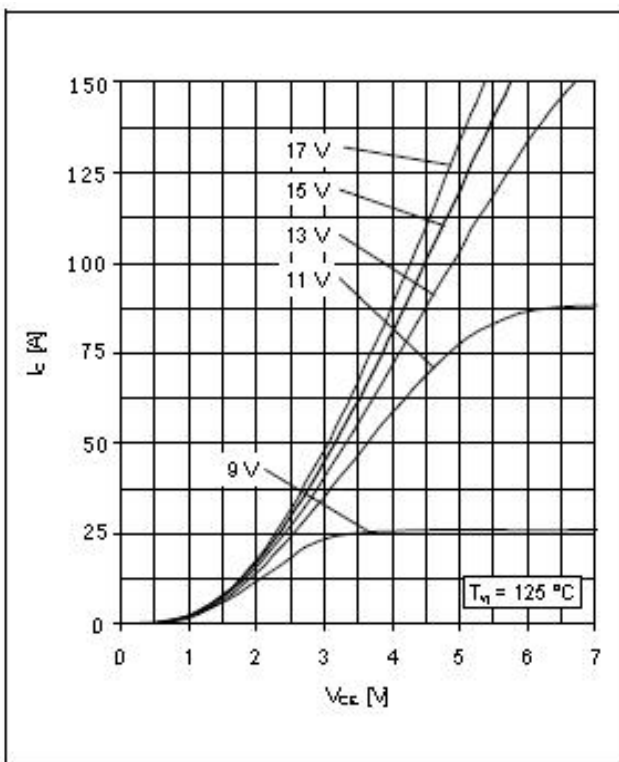

Figure 3: Output characteristic IGBT (typical)
 $I_c = f(V_{ce}), T_{vj} = 125^\circ\text{C}$

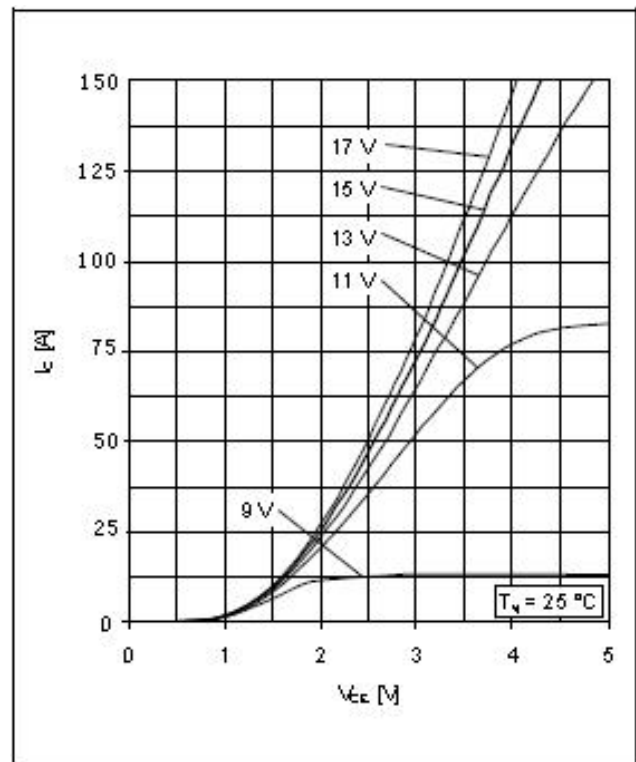

Figure 4: Output characteristic IGBT (typical)
 $I_c = f(V_{ce}), T_{vj} = 25^\circ\text{C}$

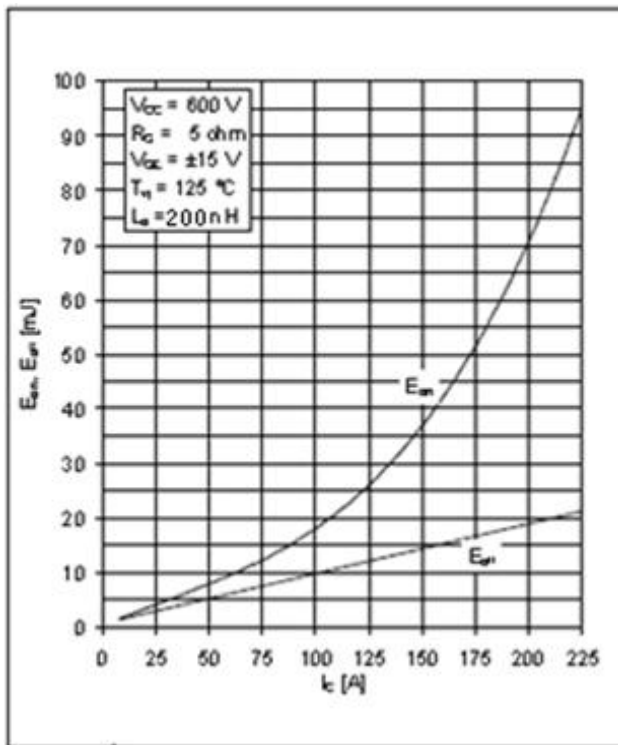

Figure 5: switching losses IGBT,Inverter(typical)
 $E_{on}=f(I_c), E_{off}=f(I_c)$ $T_{vj}=125^{\circ}\text{C}$

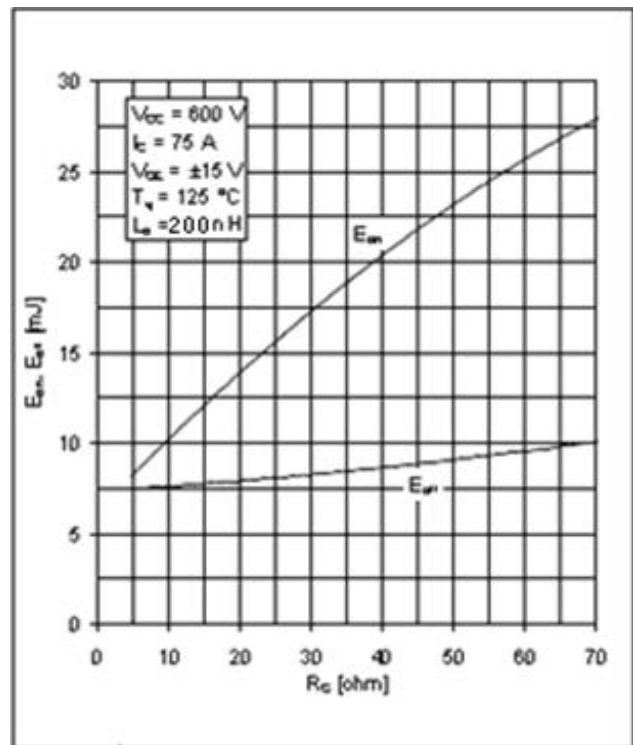

Figure 6: switching losses IGBT,Inverter(typical)
 $E_{on}=f(R_g), E_{off}=f(R_g)$ $T_{vj}=125^{\circ}\text{C}$

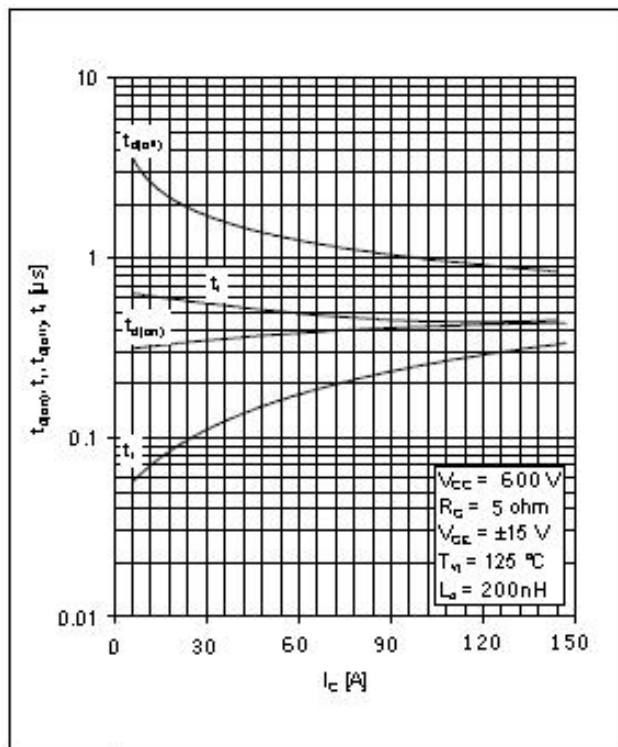

Figure 7: switching losses IGBT,Inverter(typical)
 $T_{don}=f(I_c)$ $T_{doff}=f(I_c)$ $T_r=f(I_c)$ $T_f=f(I_c)$

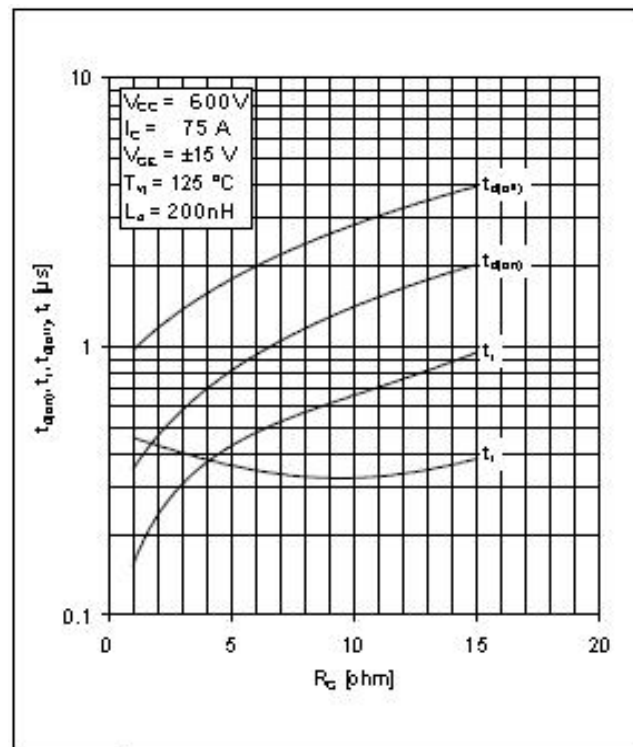

Figure 8: switching losses IGBT,Inverter(typical)
 $T_{don}=f(R_g)$ $T_{doff}=f(R_g)$ $T_r=f(R_g)$ $T_f=f(R_g)$

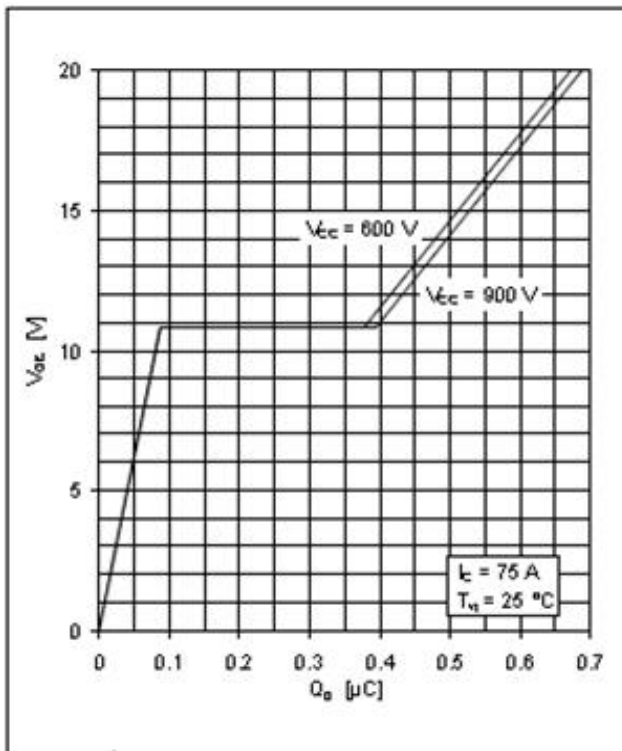

Figure 9: Gate charge, IGBT inverter (typical)
 $V_{GE} = f(Q_g)$

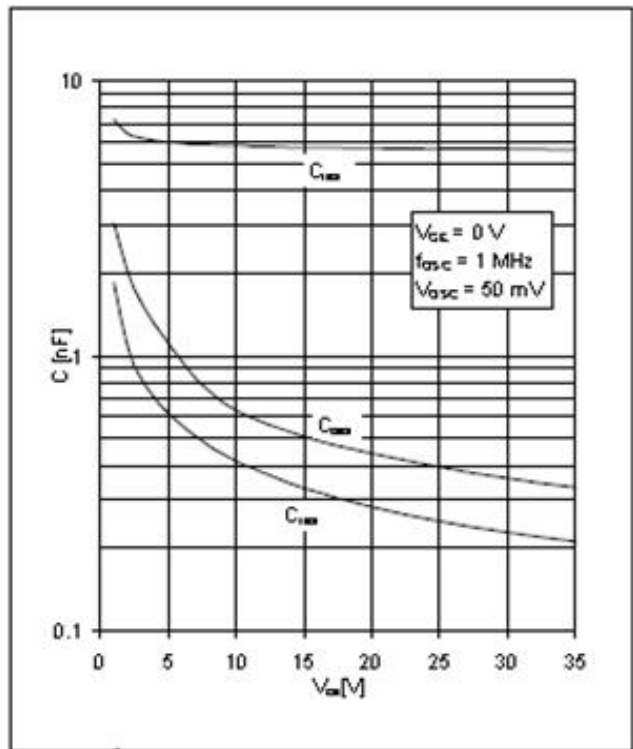

Figure 10: Output capacitance, IGBT

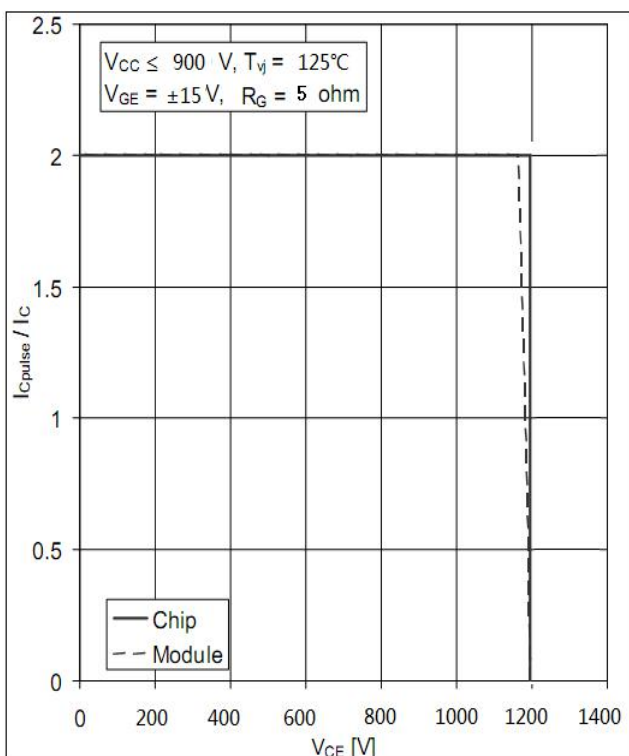

Figure 11: reverse bias safe operating area IGBT inverter (RBSOA) $I_C = f(V_{CE})$

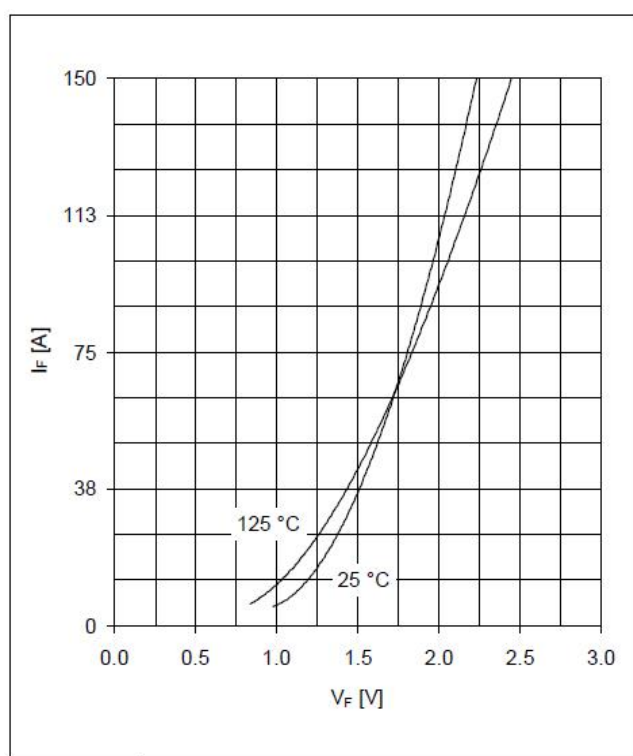

Figure 12: Forward characteristic Diode Inverter (typical)

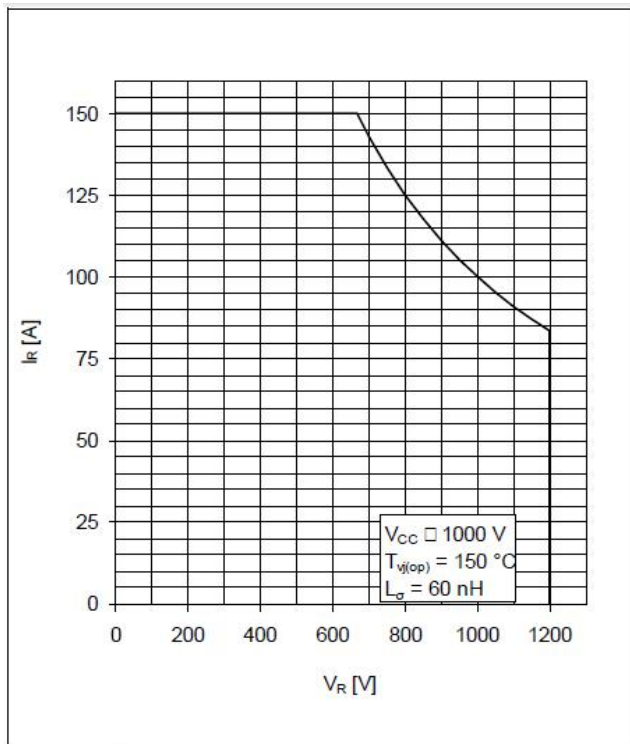

Figure 13: Safe operating area diode(SOA)

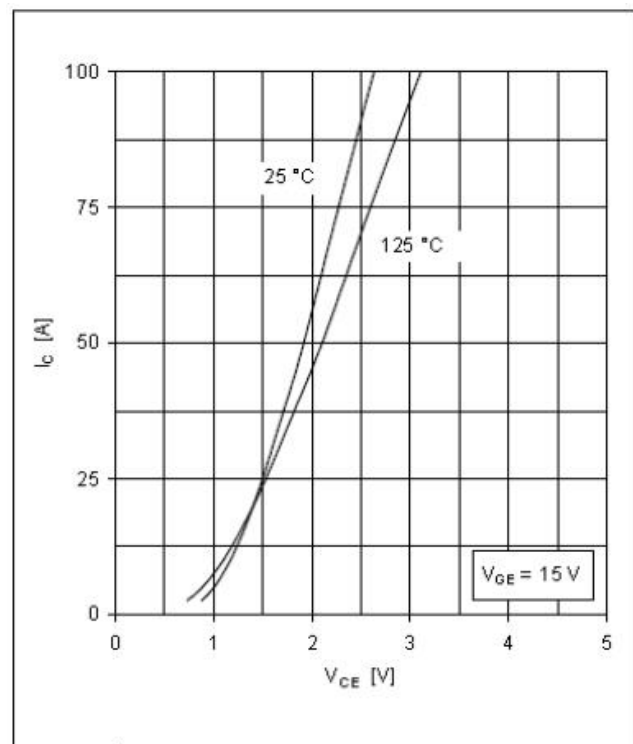

Figure 14: typical output characteristics IGBT, brake-chopper

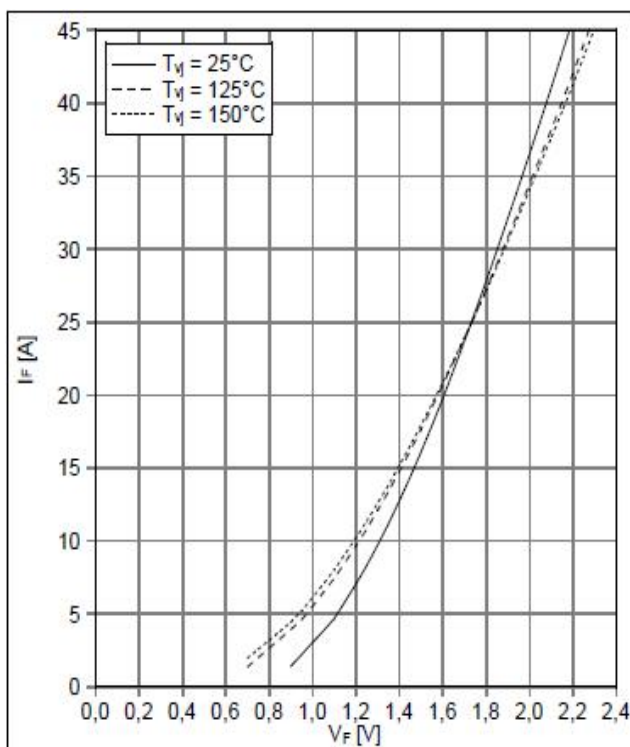

Figure 15: typical output characteristics Diode, brake-chopper

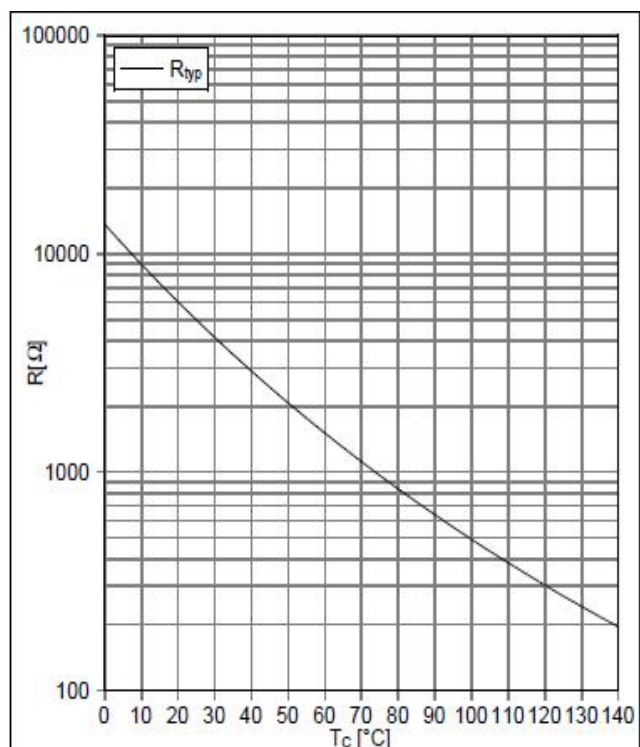
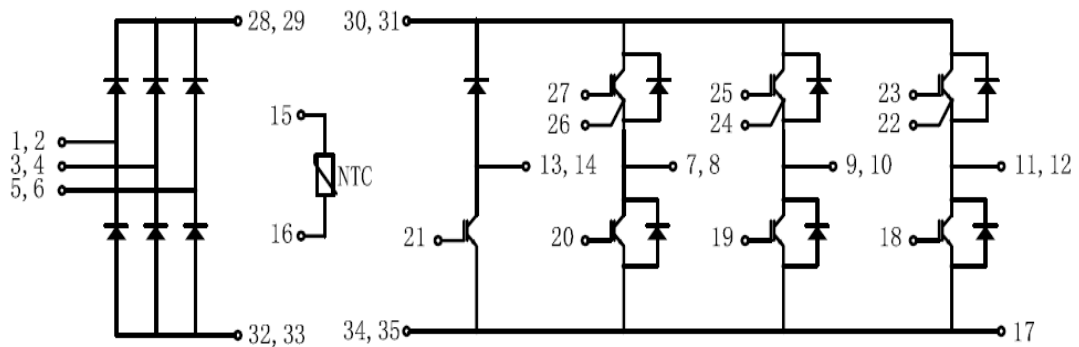
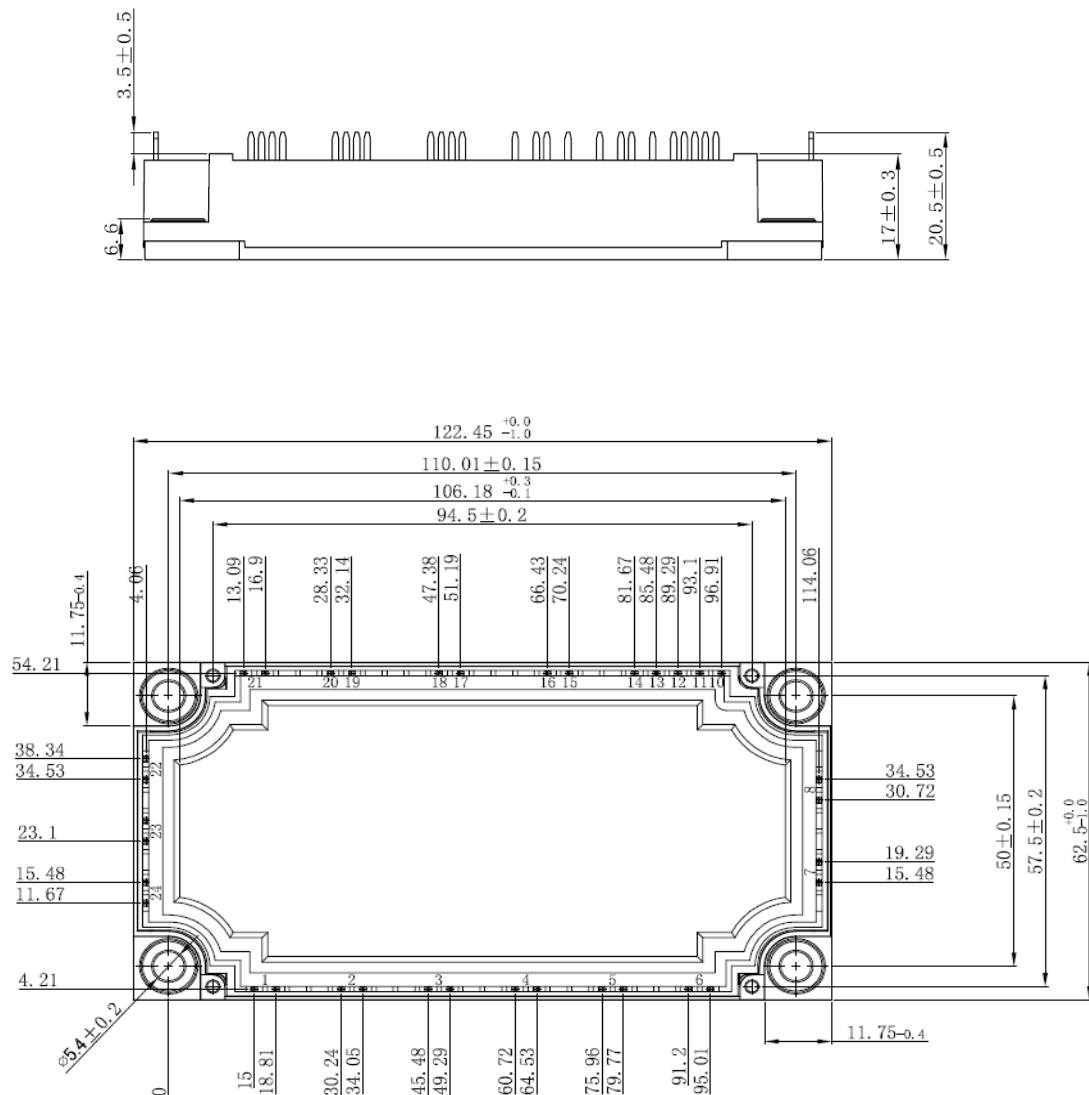

Figure 16: NTC temperature characteristic (typical)

Circuit diagram



Package outlines dimensions in mm



Published by

ShenZhen Invsemi Co.,Ltd
2nd Floor,Building 8th,HuaFeng Cyber Park,9th Baoqing Road,
Longgang District,ShenZhen,China 518119
Tel/Fax: 0755-89890048
All Rights Reserved.

Attention

- Specifications of any and all Invsemi products described or contained herein stipulate the performance, characteristics, and functions of the described products in the independent state, and are not guarantees of the performance, characteristics, and functions of the described products as mounted in the customer's products or equipment. To verify symptoms and states that cannot be evaluated in an independent device, the customer should always evaluate and test devices mounted in the customer's products or equipment.
- Any and all Invsemi products described or contained herein do not have specifications that can handle applications that require extremely high levels of reliability, such as life-support systems, aircraft's control systems, or other applications whose failure can be reasonably expected to result in serious physical and/or material damage. Consult with us described or contained herein in such applications.
- Invsemi assumes no responsibility for equipment failures that result from using products at values that exceed, even momentarily, rated values (such as maximum ratings, operating condition ranges, or other parameters) listed in products specifications of any and all Silikron products described or contained herein.
- Any and all information described or contained herein are subject to change without notice due to product/technology improvement, etc.
- We hereby disclaim any and all warranties, including but not limited to warranties of non-infringement, regarding circuits, descriptions and charts stated herein.