

**Surface Mount Fast Recovery Rectifiers**
**Reverse Voltage - 50 to 1000 V**
**Forward Current - 1 A**
**FEATURES**

- For surface mounted applications
- Low profile package
- Glass Passivated Chip Junction
- Easy to pick and place
- Fast reverse recovery time
- Lead free in comply with EU RoHS 2011/65/EU directives

**MECHANICAL DATA**

- Case: SMAF
- Terminals: Solderable per MIL-STD-750, Method 2026
- Approx. Weight: 27mg 0.00086oz

**PINNING**

PIN	DESCRIPTION
1	Cathode
2	Anode

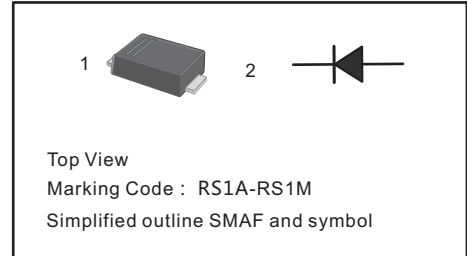
**Maximum Ratings and Electrical characteristics**

Ratings at 25 °C ambient temperature unless otherwise specified.

Single phase half-wave 60 Hz, resistive or inductive load, for capacitive load current derate by 20 %.

Parameter	Symbols	RS1AF	RS1BF	RS1DF	RS1GF	RS1JF	RS1KF	RS1MF	Units
Maximum Repetitive Peak Reverse Voltage	$V_{RRM}$	50	100	200	400	600	800	1000	V
Maximum RMS voltage	$V_{RMS}$	35	70	140	280	420	560	700	V
Maximum DC Blocking Voltage	$V_{DC}$	50	100	200	400	600	800	1000	V
Maximum Average Forward Rectified Current at $T_a = 65\text{ }^\circ\text{C}$	$I_{F(AV)}$	1							A
Peak Forward Surge Current 8.3 ms Single Half Sine Wave Superimposed on Rated Load (JEDEC Method)	$I_{FSM}$	30							A
Maximum Instantaneous Forward Voltage at 1 A	$V_F$	1.3							V
Maximum DC Reverse Current $T_a = 25\text{ }^\circ\text{C}$ at Rated DC Blocking Voltage $T_a = 125\text{ }^\circ\text{C}$	$I_R$	5 100							$\mu\text{A}$
Maximum Reverse Recovery Time <sup>1)</sup>	$t_{rr}$	150			250		500		ns
Typical Junction Capacitance <sup>2)</sup>	$C_j$	15							pF
Operating and Storage Temperature Range	$T_j, T_{stg}$	-55 ~ +150							$^\circ\text{C}$

 1 ) Measured with  $I_F = 0.5\text{ A}$ ,  $I_R = 1\text{ A}$ ,  $I_{rr} = 0.25\text{ A}$ 

2 ) Measured at 1MHz and applied reverse voltage of 4V D.C

Fig.1 Forward Current Derating Curve

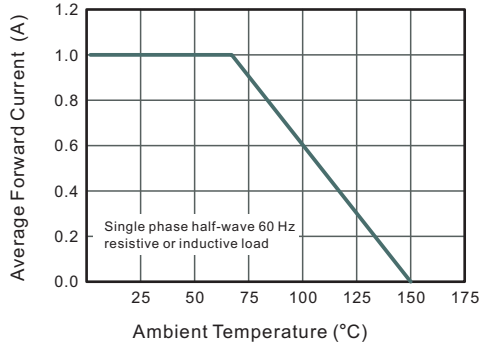

Fig.2 Typical Reverse Characteristics

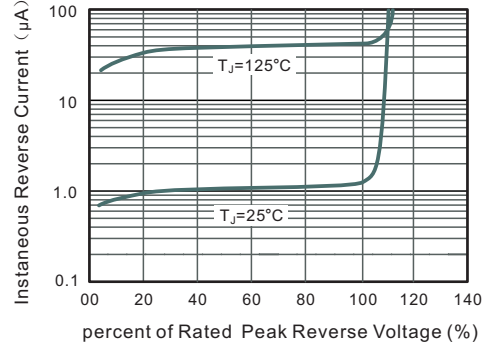

Fig.3 Typical Instantaneous Forward Characteristics

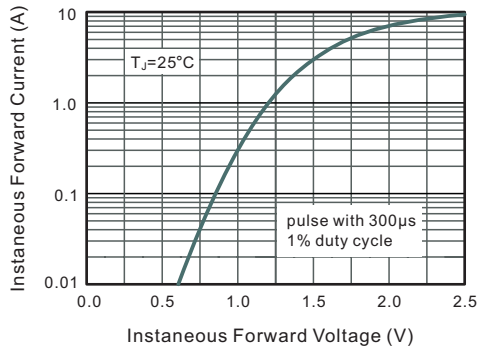

Fig.4 Typical Junction Capacitance

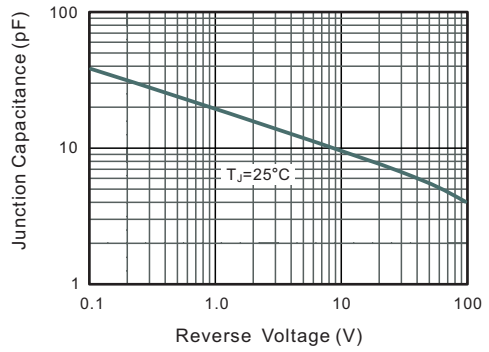
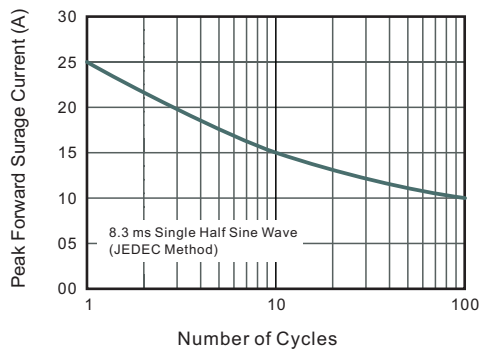

Fig.5 Maximum Non-Repetitive Peak Forward Surge Current



**PACKAGE OUTLINE**

Plastic surface mounted package; 2 leads

SMAF

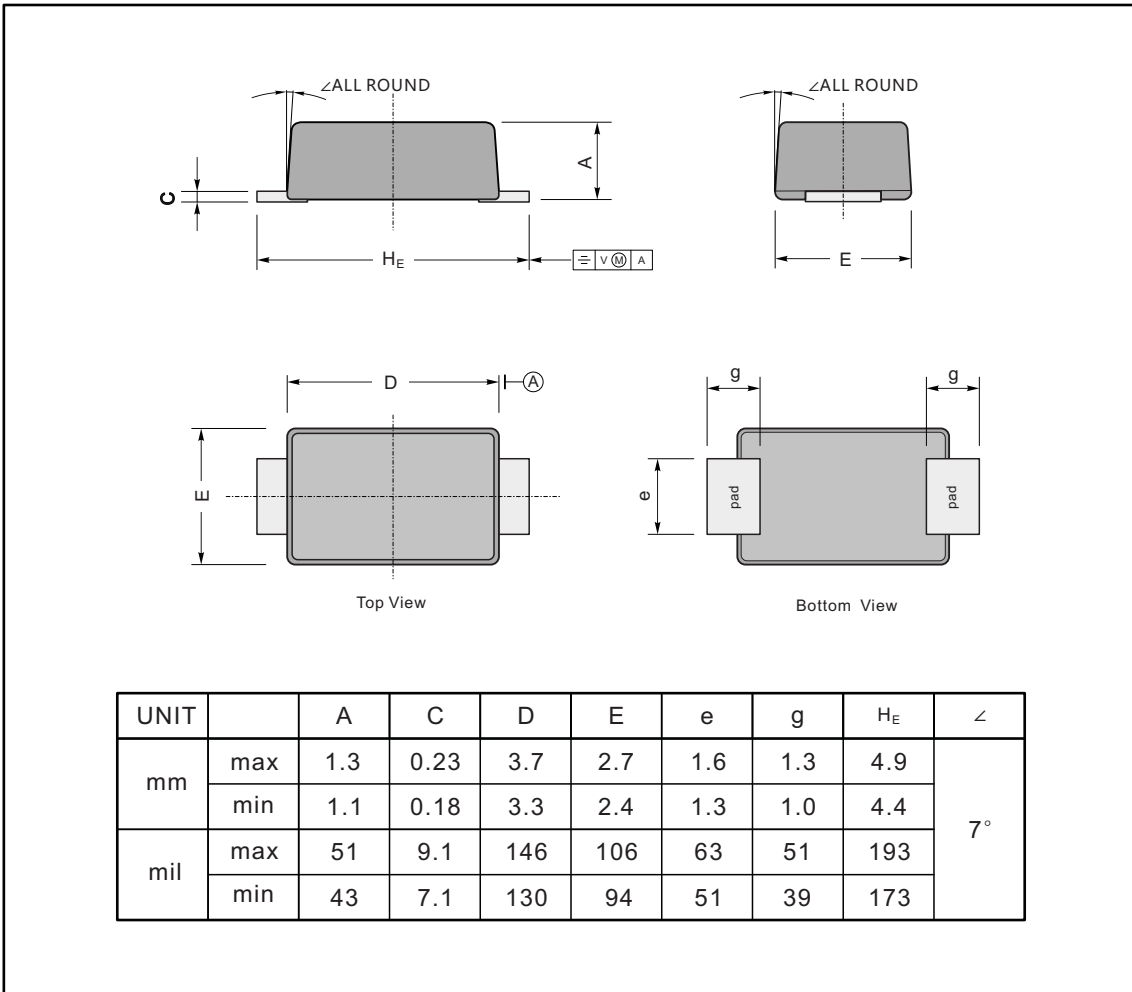

**The recommended mounting pad size**

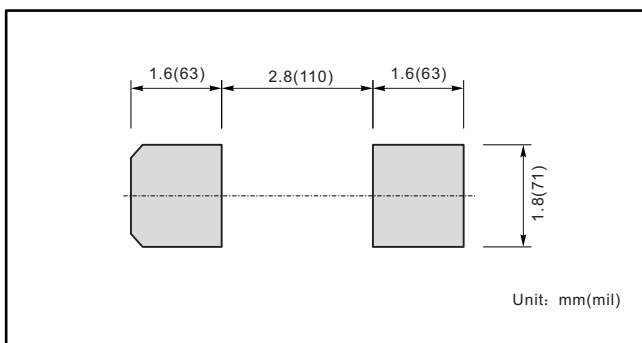

**Marking**

Type number	Marking code
RS1AF	RS1A
RS1BF	RS1B
RS1DF	RS1D
RS1GF	RS1G
RS1JF	RS1J
RS1KF	RS1K
RS1MF	RS1M